

TYPICAL SECTION

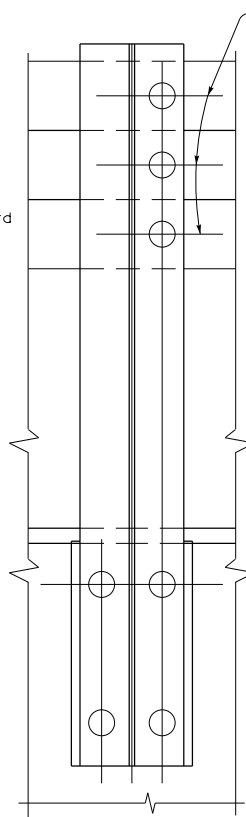

SECTION B-B

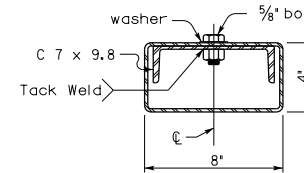

SECTION A-A

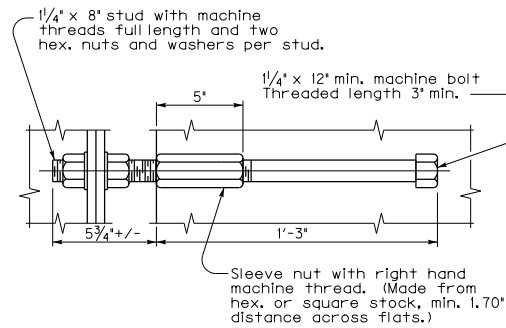
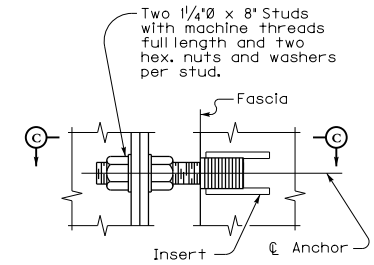

TYPE A ANCHOR DETAIL

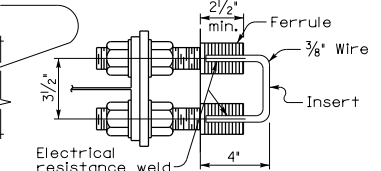

TYPE B ANCHOR DETAIL

TS 8 x 4 x 0.1875 tubing minimum length center to center with 12'-6\"/>

Notes:
Connect bridge guardrail to Roadway Guardrail, refer to Std. Dwg. BHS-007, C.E.

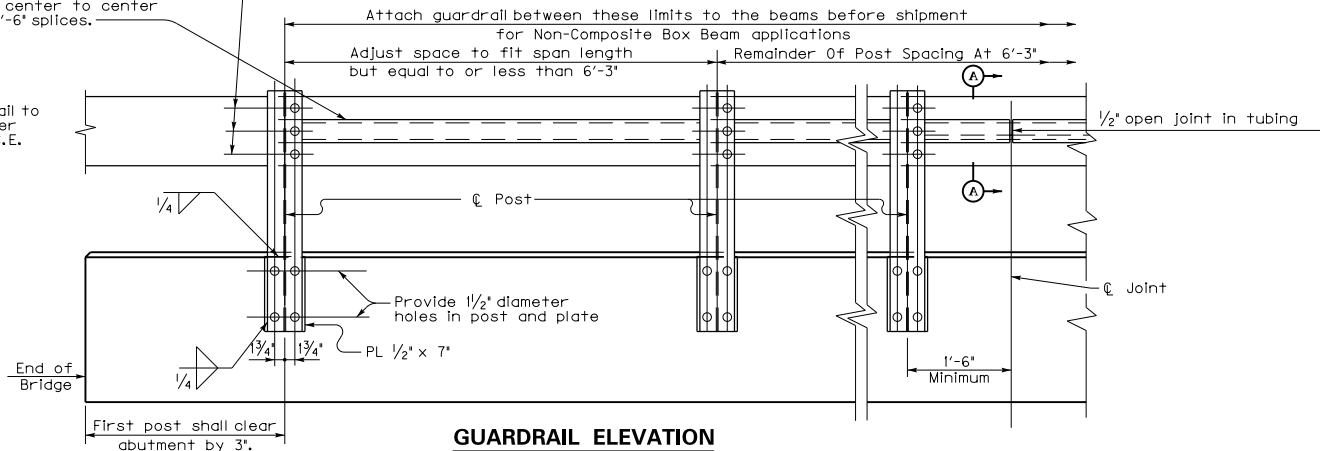

GUARDRAIL ELEVATION

Post Spacing

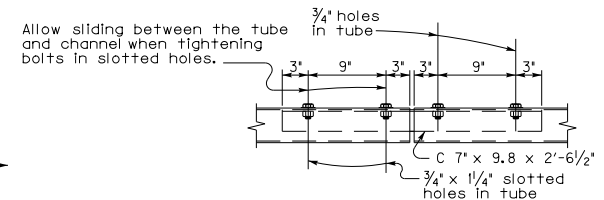

OPEN JOINT

KENTUCKY DEPARTMENT OF HIGHWAYS	
RAILING SYSTEM TYPE II	
STANDARD DRAWING NO. BDP-005-05	
SUBMITTED <i>Mark Wite</i>	DATE 12-01-15
DIRECTOR, DIVISION OF STRUCTURAL DESIGN	
APPROVED <i>[Signature]</i>	DATE 12-01-15
STATE HIGHWAY ENGINEER	